

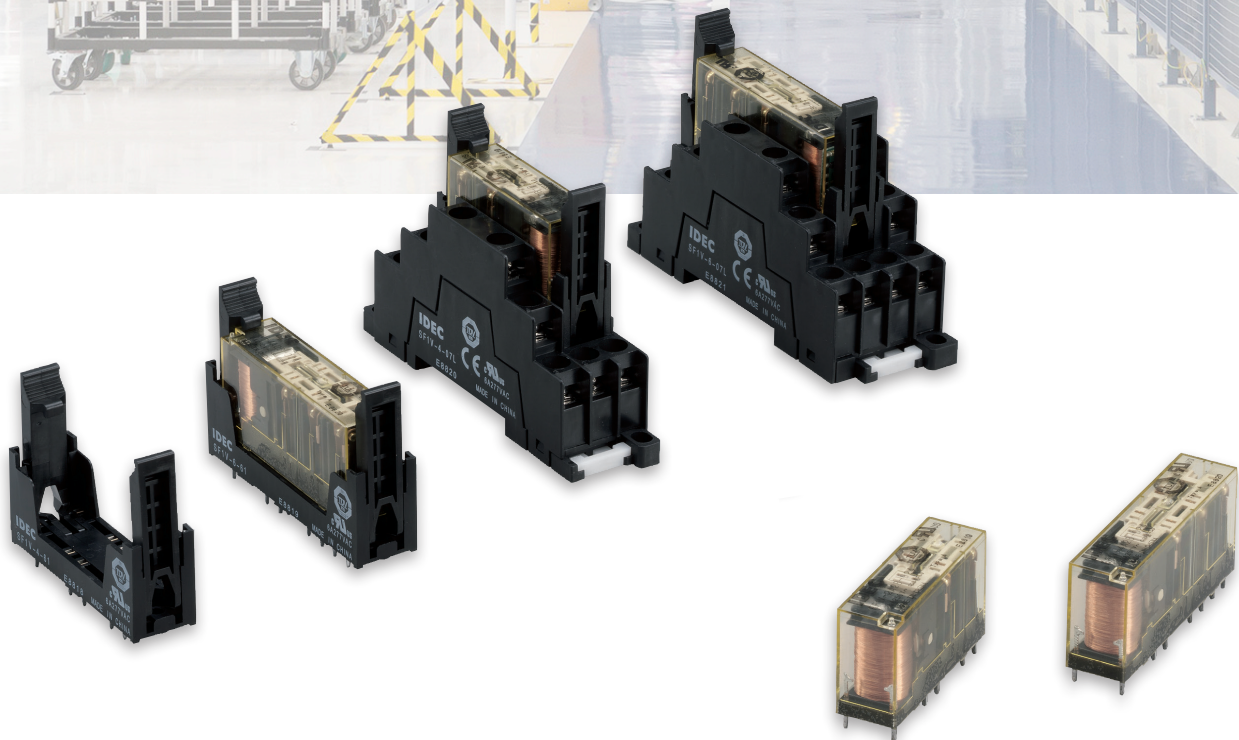

Think Automation and beyond...

# RF1V Force Guided Relays SF1V Relay Sockets



IDEC CORPORATION

# Enables flexible construction of safety circuits

## Complies with International Standards

Force guided contact mechanism  
(EN50205 Type A TÜV approved)



## Fast Response Time

Response time of 8 ms.  
Ensures safety by turning the load off quickly.

## High Shock Resistance

High shock resistant suitable for use in machine tools and in environments subjected to vibration and shocks. (200 m/s<sup>2</sup> minimum)

## Clear Visibility

Available with a built-in LED.

## Compact and Slim

Compact size enables size reduction of PC board.  
4-pole type: 13W × 40D × 24H mm  
6-pole type: 13W × 50D × 24H mm

## Socket Variation

PC board mount and DIN rail mount sockets are available.  
Relays can be replaced easily.



PC board mount    DIN rail mount

## Counter-electromotive force diode model

The diode protects the operating coil circuit from counter electromotive force when the relay is deenergized.

## What is a force guided relay?

Relays used in safety circuits to detect failures such as contact welding and damage to the contact spring.

Contacts of a force guided relay are forced to open and close by a guide connected to the armature.

Due to requirements of standard EN50205, a force guided relay has independent NO and NC contacts. If a NO contact welds, a NC contact will not close even when the relay coil is turned off (de-energized) and must maintain a gap of at least 0.5 mm. Furthermore, if a NC contact welds, a NO contact will not close when the relay is turned on (energized) and must maintain a gap of at least 0.5 mm. (General-purpose relays do not have the above characteristics.)

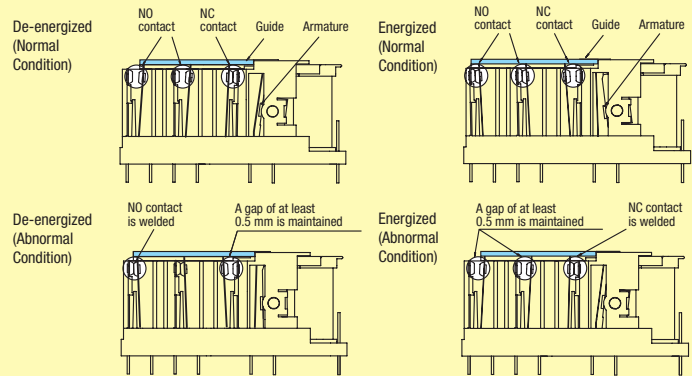
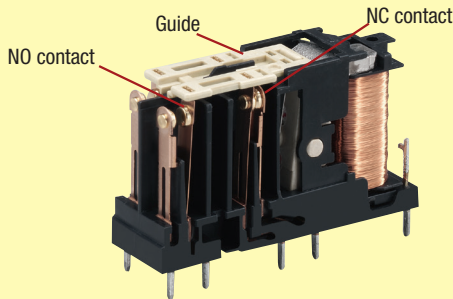

## Applications

Force guided relays are used in safety circuits in combination with interlock switches, light curtains, and emergency stop switches to control outputs. They can also be used to expand outputs for safety relay modules and safety controllers.

## Output expansion for safety relay modules and safety controllers

### HR1S Safety Relay Module

Cost effective and easy method to expand mechanical contact outputs.

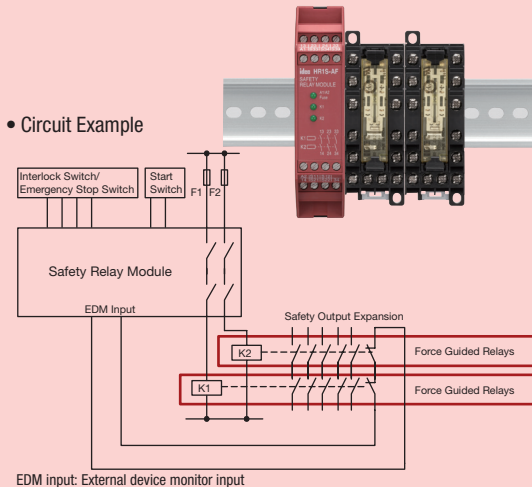

### FS1A Safety Controller

Solid state safety outputs of safety controllers can be converted to mechanical contact outputs.

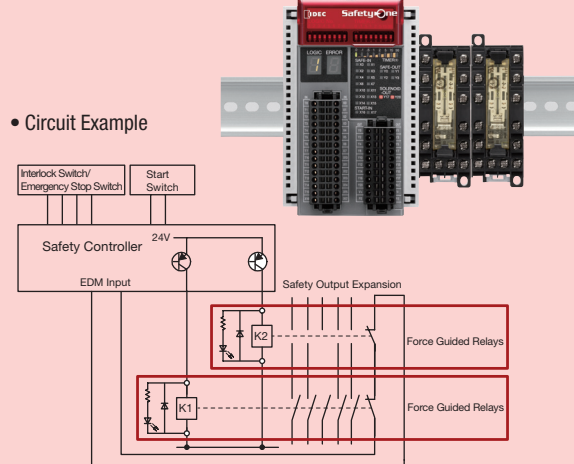

# RF1V Force-guided Relays

## SF1V Relay Sockets

### Compact and EN compliant RF1V force guided relays.

- Force guided contact mechanism (EN50205 Type A TÜV approved)
- Contact configuration
  - 4-pole (2NO-2NC, 3NO-1NC)
  - 6-pole (4NO-2NC, 5NO-1NC, 3NO-3NC)
- Built-in LED indicator model and counter-electromotive force diode model are available.
- Fast response time (8 ms maximum).
- High shock resistance (200 m/s<sup>2</sup> minimum)
- Finger-safe DIN rail mount socket and PC board mount socket.

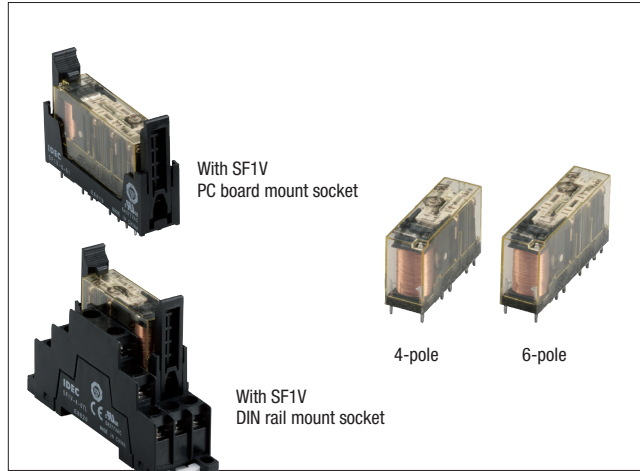

### Applicable Standards

UL508		UL recognized File No. E55996
CSA C22.2 No. 14		CSA File No. 253350
EN50205 EN61810-1		TÜV SÜD

Contact	Rated Coil Voltage	Without LED Indicator	With LED Indicator	With Counter-electromotive Force Diode With LED Indicator
		Part No.	Part No.	Part No.
4-pole	2NO-2NC	12V DC	RF1V-2A2B-D12	RF1V-2A2BL-D12
		24V DC	RF1V-2A2B-D24	RF1V-2A2BL-D24
		48V DC	RF1V-2A2B-D48	RF1V-2A2BL-D48
	3NO-1NC	12V DC	RF1V-3A1B-D12	RF1V-3A1BL-D12
		24V DC	RF1V-3A1B-D24	RF1V-3A1BL-D24
		48V DC	RF1V-3A1B-D48	RF1V-3A1BL-D48
6-pole	4NO-2NC	12V DC	RF1V-4A2B-D12	RF1V-4A2BL-D12
		24V DC	RF1V-4A2B-D24	RF1V-4A2BL-D24
		48V DC	RF1V-4A2B-D48	RF1V-4A2BL-D48
	5NO-1NC	12V DC	RF1V-5A1B-D12	RF1V-5A1BL-D12
		24V DC	RF1V-5A1B-D24	RF1V-5A1BL-D24
		48V DC	RF1V-5A1B-D48	RF1V-5A1BL-D48
	3NO-3NC	12V DC	RF1V-3A3B-D12	RF1V-3A3BL-D12
		24V DC	RF1V-3A3B-D24	RF1V-3A3BL-D24
		48V DC	RF1V-3A3B-D48	RF1V-3A3BL-D48

### Sockets

Types	No. of Poles	Part No.
DIN Rail Mount Sockets	4	SF1V-4-07L
	6	SF1V-6-07L
PC Board Mount Sockets	4	SF1V-4-61
	6	SF1V-6-61

### Certification for Sockets

UL508		UL recognized File No. E62437
CSA C22.2 No.14		CSA File No. 253350
EN147000 EN147100		TÜV SÜD
		EU Low Voltage Directive (DIN rail mount sockets only)

### Coil Ratings

Contact	Rated Coil Voltage (V)	Rated Current (mA) ±10% (at 20°C) (Note 1)	Coil Resistance (Ω) ±10% (at 20°C)	Operating Characteristics (at 20°C)			Power Consumption
				Pickup Voltage (initial value)	Dropout Voltage (initial value)	Maximum Continuous Applied Voltage (Note 2)	
4-pole	2NO-2NC	12V DC	30.0	75% maximum	10% minimum	110%	Approx. 0.36W
		24V DC	15.0				
		48V DC	7.5				
	3NO-1NC	12V DC	30.0				
		24V DC	15.0				
		48V DC	7.5				
6-pole	4NO-2NC	12V DC	41.7				
		24V DC	20.8				
		48V DC	10.4				
	5NO-1NC	12V DC	41.7				
		24V DC	20.8				
		48V DC	10.4				
	3NO-3NC	12V DC	41.7				
		24V DC	20.8				
		48V DC	10.4				

Note 1: For relays with LED indicator, the rated current increases by approx. 2 mA. Note 2: Maximum continuous applied voltage is the maximum voltage that can be applied to relay coils.

## Relay Specifications

Number of Poles	4-pole		6-pole		
Contact Configuration	2NO-2NC	3NO-1NC	4NO-2NC	5NO-1NC	3NO-3NC
Contact Resistance (initial value) (Note 1)	100 mΩ maximum				
Contact Material	AgSnO <sub>2</sub> (Au flashed)				
Rated Load (resistive load)	6A 250V AC, 6A 30V DC				
Allowable Switching Power (resistive load)	1500 VA, 180W DC (30V DC max.), 85W DC (30V to 120V DC max.)				
Allowable Switching Voltage	250V AC, 125V DC				
Allowable Switching Current	6A				
Minimum Applicable Load (Note 2)	5V DC, 1 mA (reference value)				
Power Consumption (approx.)	0.36W		0.50W		
Insulation Resistance	1000 MΩ minimum (500V DC megger, same measurement positions as the dielectric strength)				
Dielectric Strength	Between contact and coil		4000V AC, 1 minute		
	Between contacts of different poles		2500V AC, 1 minute Between contacts 7-8 and 9-10		2500V AC, 1 minute Between contacts 7-8 and 11-12 Between contacts 9-10 and 13-14 Between contacts 11-12 and 13-14
			4000V AC, 1 minute Between contacts 3-4 and 5-6 Between contacts 3-4 and 7-8 Between contacts 5-6 and 9-10		4000V AC, 1 minute Between contacts 3-4 and 5-6 Between contacts 3-4 and 7-8 Between contacts 5-6 and 9-10 Between contacts 7-8 and 9-10
	Between contacts of the same pole		1500V AC, 1 minute		
Operate Time (at 20°C)	20 ms maximum (at the rated coil voltage, excluding contact bounce time)				
Response Time (at 20°C) (Note 3)	8 ms maximum (at the rated coil voltage, excluding contact bounce time, without diode) (Note 4)				
Release Time (at 20°C)	20 ms maximum (at the rated coil voltage, excluding contact bounce time, without diode)				
Vibration Resistance	Operating Extremes		10 to 55 Hz, amplitude 0.75 mm		
	Damage Limits		10 to 55 Hz, amplitude 0.75 mm		
Shock Resistance	Operating Extremes (half sine-wave pulse: 11 ms)		200 m/s <sup>2</sup> , when mounted on DIN rail mount socket: 150 m/s <sup>2</sup>		
	Damage Limits (half sine-wave pulse: 6 ms)		1000 m/s <sup>2</sup>		
Electrical Life	250V AC 6A resistive load: 100,000 operations minimum (operating frequency 1200 per hour) 30V DC 6A resistive load: 100,000 operations minimum (operating frequency 1200 per hour) 250V AC 1A resistive load: 500,000 operations minimum (operating frequency 1800 per hour) 30V DC 1A resistive load: 500,000 operations minimum (operating frequency 1800 per hour) [AC 15] 240V AC 2A inductive load: 100,000 operations minimum (operating frequency 1200 per hour, cos φ = 0.3) [DC 13] 24V DC 1A inductive load: 100,000 operations minimum (operating frequency 1200 per hour, L/R = 48 ms)				
Mechanical Life	10 million operations minimum (operating frequency 10,800 operations per hour)				
Operating Temperature (Note 5)	-40 to +85°C (no freezing)				
Operating Humidity	5 to 85%RH (no condensation)				
Storage Temperature	-40 to +85°C (no freezing)				
Storage Humidity	5 to 85%RH (no condensation)				
Operating Frequency (rated load)	1200 operations per hour				
Weight (approx.)	20g		23g		

Note 1: Measured using 6V DC, 1A voltage drop method.

Note 2: Failure rate level P (reference value)

Note 3: Response time is the time until NO contact opens, after the coil voltage is turned off.

Note 4: With diode: 12ms maximum (at the rated coil voltage, excluding contact bounce time)

Note 5: See the table below for the current and operating temperature

## Socket Specifications

Model	SF1V-4-07L	SF1V-6-07L	SF1V-4-61	SF1V-6-61
Rated Current	6A			
Rated Voltage	250V AC/DC			
Insulation Resistance	1000 MΩ minimum (500V DC megger, between terminals)			
Applicable Wire	0.7 to 1.65 mm <sup>2</sup> (18 AWG to 14 AWG)		—	
Recommended Screw Tightening Torque	0.5 to 0.8 N·m		—	
Screw Terminal Style	M3 slotted Phillips self-tapping screw		—	
Terminal Strength	Wire tensile strength: 50N min.		—	
Dielectric Strength	2500V AC, 1 minute (Between live and dead metal parts, between live parts of different poles)			
Vibration Resistance	Damage limits: 10 to 55 Hz, amplitude 0.75 mm Resonance: 10 to 55 Hz, amplitude 0.75 mm			
Shock Resistance	1000 m/s <sup>2</sup>			
Operating Temperature (Note)	-40 to +85°C (no freezing)			
Operating Humidity	5 to 85% RH (no condensation)			
Storage Temperature	-40 to +85°C (no freezing)			
Storage Humidity	5 to 85% RH (no condensation)			
Degree of Protection	IP20 (finger-safe screw terminals)		—	
Weight (approx.)	40g	55g	9g	10g

Note: See the table at right for the current and operating temperature.

## Operating Temperature (relay, socket)

	Single mounting	Collective mounting	
Operating Temperature	-40°C to +85°C	4-pole	-40°C to +70°C
		6-pole	-40°C to +65°C
Contact Current	6A	6A	
Remarks	When the ambient temperature is over 70°C, lower the contact current at 0.1A/°C. Up to 70°C: Keep the total current of NO side to 24A maximum. Over 70°C: Lower the contact current at 0.1A/°C.	4-pole	When the ambient temperature is over 60°C, lower the contact current at 0.1A/°C.
		6-pole	When the ambient temperature is over 50°C, lower the contact current at 0.1A/°C. Up to 50°C: Keep the total current of NO side to 24A maximum. Over 50°C: Lower the contact current at 0.1A/°C.

## Applicable Crimping Terminal

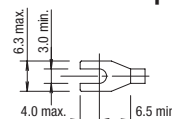

All dimensions in mm.

Note: Ring tongue terminals cannot be used.

## Accessories

Item	Shape	Specifications	Part No.
DIN Rail		Aluminum Weight: Approx. 200g	<b>BAA1000</b>
		Steel Weight: Approx. 320g	<b>BAP1000</b>
End Clip		Metal (zinc plated steel) Weight: Approx. 15g	<b>BNL5</b>
			<b>BNL6</b>

## Characteristics

### Maximum Switching Capacity

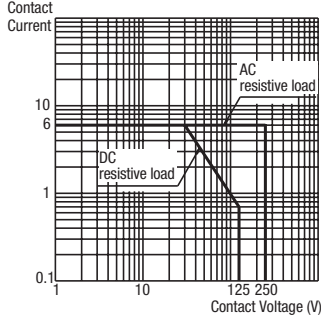

### Electrical Life Curve

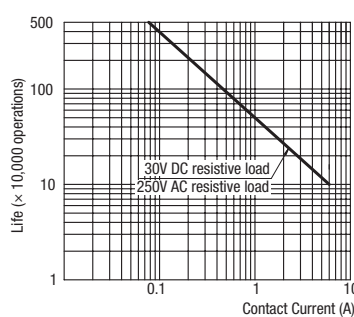

## Notes on Contact Gaps except Welded Contacts

Example: RF1V-2A2B-D24

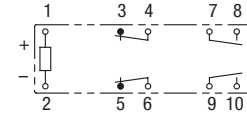

- If the NO contact (7-8 or 9-10) welds, the NC contact (3-4 or 5-6) remains open even when the relay coil is de-energized, maintaining a gap of 0.5 mm minimum. The remaining unwelded NO contact (9-10 or 7-8) is either open or closed.
- If the NC contact (3-4 or 5-6) welds, the NO contact (7-8 or 9-10) remains open even when the relay coil is energized, maintaining a gap of 0.5 mm minimum. The remaining unwelded NC contact (5-6 or 3-4) is either open or closed.

## Dimensions

(All dimensions in mm.)

### RF1V Relays

#### RF1V (4-pole)

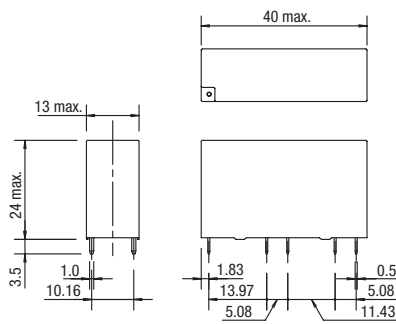

#### RF1V (6-pole)

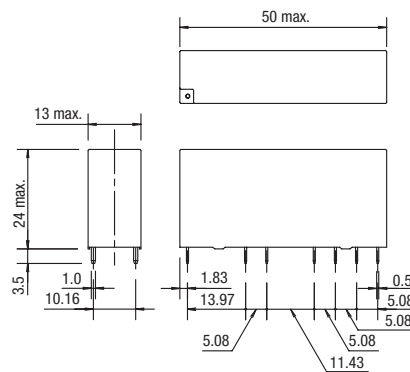

### PC Board Terminal Model

#### Mounting Hole Layout (Bottom View)

##### RF1V (4-pole)

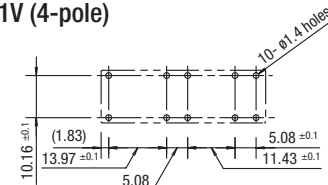

##### RF1V (6-pole)

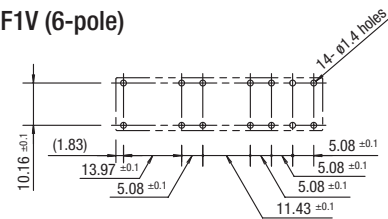

## Internal Connection (Bottom View)

### RF1V (4-pole)

Without LED Indicator

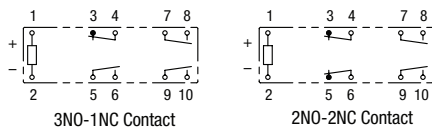

With LED Indicator

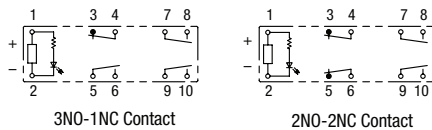

With Counter-electromotive Force Diode

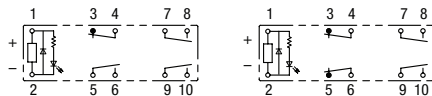

### RF1V (6-pole)

Without LED Indicator

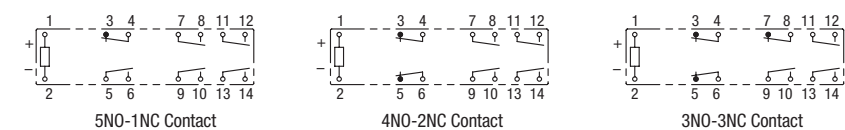

With LED Indicator

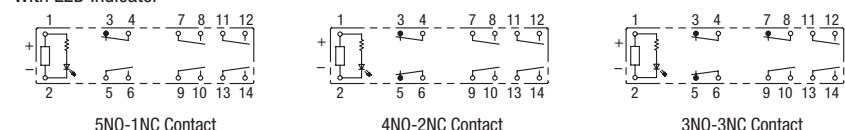

With Counter-electromotive Force Diode

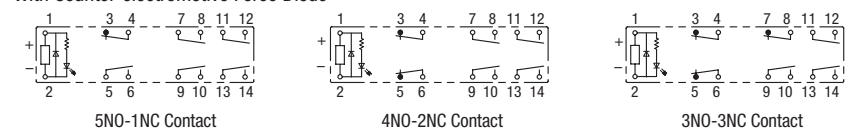

## Dimensions (All dimensions in mm.)

### SF1V PC Board Mount Sockets

#### SF1V (4-pole)

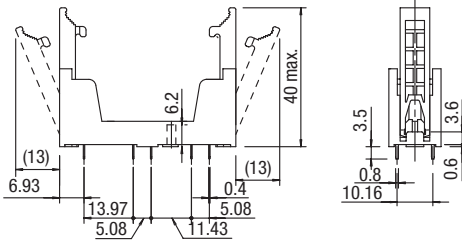
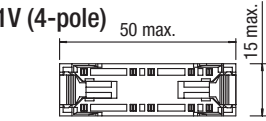

PC Board Mounting Hole Layout / Terminal Arrangement (Bottom View)

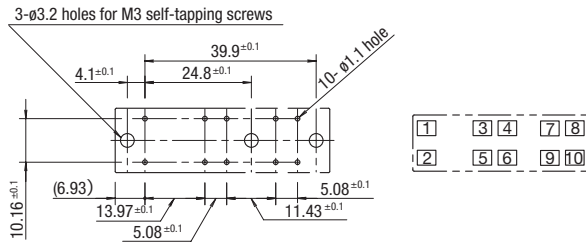

#### SF1V (6-pole)

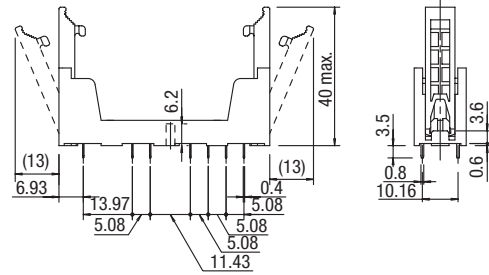
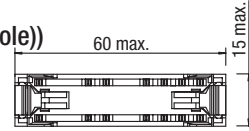

PC Board Mounting Hole Layout / Terminal Arrangement (Bottom View)

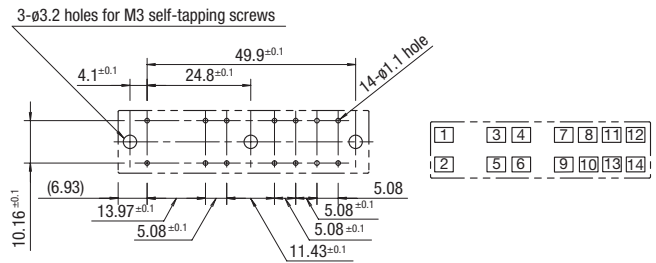

### SF1V DIN Rail Mount Socket Dimensions

#### SF1V (4-pole)

(Internal Connection)

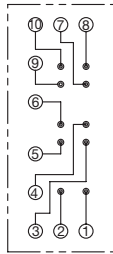

(Top View)

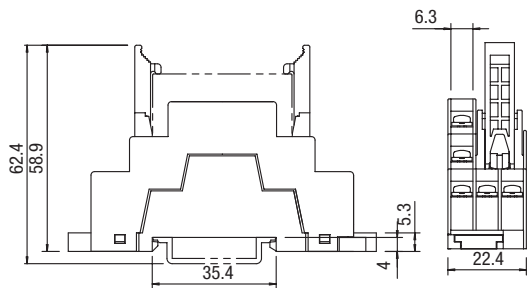
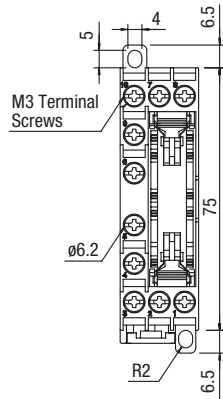

(Panel Mounting Hole Layout)

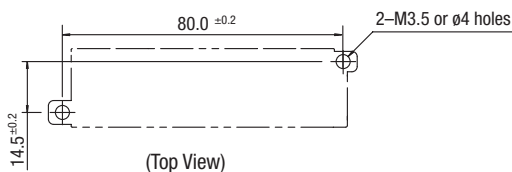

(Top View)

#### SF1V (6-pole)

(Internal Connection)

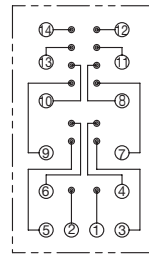

(Top View)

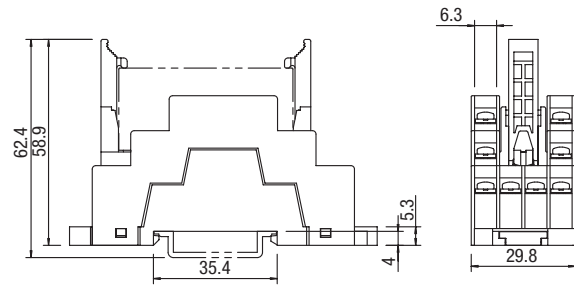
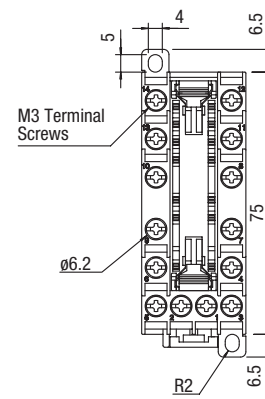

(Panel Mounting Hole Layout)

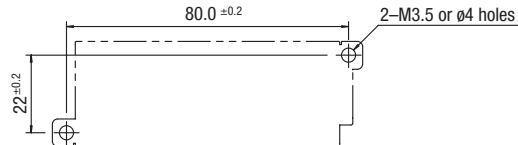

(Top View)

## Operating Instructions

### 1. Driving Circuit for Relays

- To make sure of correct relay operation, apply rated voltage to the relay coil. Pickup and dropout voltages may differ according to operating temperature and conditions.
- Input voltage for DC coil:  
A complete DC voltage is best for the coil power to make sure of stable operation. When using a power supply containing a ripple voltage, suppress the ripple factor within 5%. When power is supplied through a rectifications circuit, relay operating characteristics, such as pickup voltage and dropout voltage, depend on the ripple factor. Connect a smoothing capacitor for better operating characteristics as shown below.

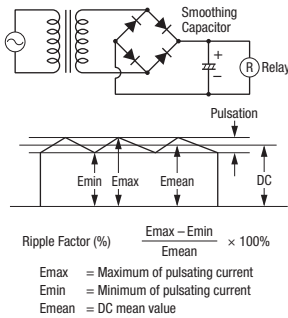

### 3. Operating the relay in sync with an AC load:

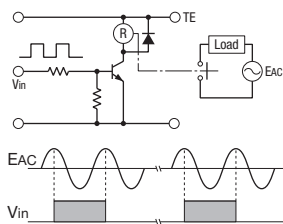

If the relay operates in sync with AC power voltage of the load, the relay life may be reduced. If this is the case, select a relay in consideration of the required reliability for the load. Or, make the relay turn on and off irrespective of the AC power phase or near the point where the AC phase crosses zero voltage.

### 4. Leakage current while relay is off:

When driving an element at the same time as the relay operation, special consideration is needed for the circuit design. As shown in the incorrect circuit below, leakage current ( $I_0$ ) flows through the relay coil while the relay is off. Leakage current causes coil release failure or adversely affects the vibration resistance and shock resistance. Design a circuit as shown in the correct example.

Incorrect

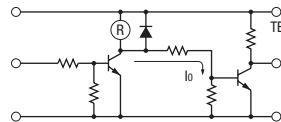

Correct

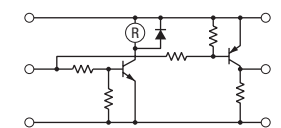

- Surge suppression for transistor driving circuits:  
When the relay coil is turned off, a high-voltage pulse is generated. Be sure to connect a diode to suppress the counter electromotive force, or use RF1V with counter-electromotive force diode. Then, the coil release time becomes slightly longer. To shorten the coil release time, connect a Zener diode between the collector and emitter of the controlling transistor. Select a Zener diode with a Zener voltage slightly higher than the power voltage.

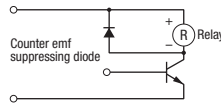

- The coil terminal of the relay has polarity. Connect terminals according to the internal connection diagram. Incorrect wiring may cause malfunction.

### 2. Protection for Relay Contacts

- The contact ratings show maximum values. Make sure that these values are not exceeded even momentarily. When an inrush current flows through the load, the contact may become welded. If this is the case, connect a contact protection circuit, such as a current limiting resistor.
- Contact protection circuit:  
When switching an inductive load, arcing causes carbides to form on the contacts, resulting in an increased contact resistance. In consideration of contact reliability, contact life, and noise suppression, use of a surge absorbing circuit is recommended. Note that the release time of the load becomes slightly longer. Check the operation using an actual load. Incorrect use of a contact protection circuit will adversely affect switching characteristics. Four typical examples of contact protection circuits are shown in the following table:

RC		This protection circuit can be used when the load impedance is smaller than the RC impedance in an AC load power circuit. R: Resistor of approximately the same resistance value as the load C: 0.1 to 1 μF
		This protection circuit can be used for both AC and DC load power circuits. R: Resistor of approximately the same resistance value as the load C: 0.1 to 1 μF
Diode		This protection circuit can be used for DC load power circuits. Use a diode with the following ratings. Reverse withstand voltage: Power voltage of the load circuit × 10 Forward current: More than the load current
Varistor		This protection circuit can be used for both AC and DC load power circuits. For a best result, when using on a power voltage of 24 to 48V AC/DC, connect a varistor across the load. When using on a power voltage of 100 to 240V AC/DC, connect a varistor across the contacts.

- Do not use a contact protection circuit as shown below:

	This protection circuit is very effective in arc suppression when opening the contacts. But, the capacitor is charged while the contacts are opened. When the contacts are closed, the capacitor is discharged through the contacts, increasing the possibility of contact welding.
	This protection circuit is very effective in arc suppression when opening the contacts. But, when the contacts are closed, a current flows to charge the capacitor, causing contact welding.

Generally, switching a DC inductive load is more difficult than switching a DC resistive load. Using an appropriate arc suppressor will improve the switching characteristics of a DC inductive load.

### 3. Usage, transport, and storage conditions

- Temperature, humidity, atmospheric pressure during usage, transport, and storage.
  - Temperature: -40°C to +85°C (no freezing)  
See page 4 for the current and operating temperature.
  - Humidity: 5 to 85%RH (no condensation)  
The humidity range varies with temperature. Use within the range indicated in the chart below.
  - Atmospheric pressure: 86 to 106 kPa

### Operating temperature and humidity range

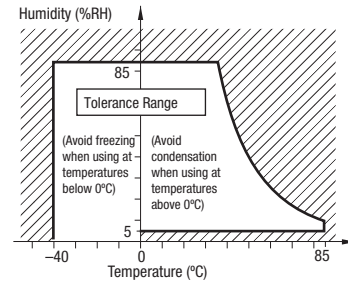

- Condensation  
Condensation occurs when there is a sudden change in temperature under high temperature and high humidity conditions. The relay insulation may deteriorate due to condensation.
- Freezing  
Condensation or other moisture may freeze on the relay when the temperatures is lower than 0°C. This causes problems such as sticking of movable parts or delay in operation.
- Low temperature, low humidity environments  
Plastic parts may become brittle when used in low temperature and low humidity environments.

### 4. Panel Mounting

When mounting DIN rail mount sockets on a panel, take the following into consideration.

- Use M3.5 screws, spring washers, and hex nuts.
- For mounting hole layout, see dimensions on page 6.
- Keep the tightening torque within 0.49 to 0.68 N·m. Excessive tightening may cause damage to the socket.

### 5. Others

- General notice
  - To maintain the initial characteristics, do not drop or shock the relay.
  - The relay cover cannot be removed from the base during normal operation. To maintain the initial characteristics, do not remove the relay cover.
  - Use the relay in environments free from condensation, dust, sulfur dioxide (SO<sub>2</sub>), and hydrogen sulfide (H<sub>2</sub>S).
  - The RF1V relay cannot be washed as it is not a sealed type. Also make sure that flux does not leak to the PC board and enter the relay.
- Connecting outputs to electronic circuits:  
When the output is connected to a load which responds very quickly, such as an electronic circuit, contact bouncing causes incorrect operation of the load. Take the following measures into consideration.
  - Connect an integration circuit.
  - Suppress the pulse voltage due to bouncing within the noise margin of the load.
- Do not use relays in the vicinity of strong magnetic field, as this may affect relay operation.
- UL and CSA ratings may differ from product rated values determined by IDEC.

## Operating Instructions

### 6. Notes on PC Board Mounting

- When mounting 2 or more relays on a PC board, keep a minimum spacing of 10 mm in each direction. If used without spacing of 10 mm, rated current and operating temperature differs. Consult IDEC.
- Manual soldering: Solder the terminals at 400°C within 3 sec.
- Auto-soldering: Preliminary heating at 120°C within 120 sec. Solder at 260°C±5°C within 6 sec.

- Because the terminal part is filled with epoxy resin, do not excessively solder or bend the terminal. Otherwise, air tightness will degrade.
- Avoid the soldering iron from touching the relay cover or the epoxy filled terminal part.
- Use a non-corrosive resin flux.

## RF2 2-pole Force Guided Relays

Ideal for applications requiring 1NO-1NC contact.

Reduce cost and installation space.

Complies with safety standards

Force guided contact mechanism  
(EN50205 Type A TÜV approved)

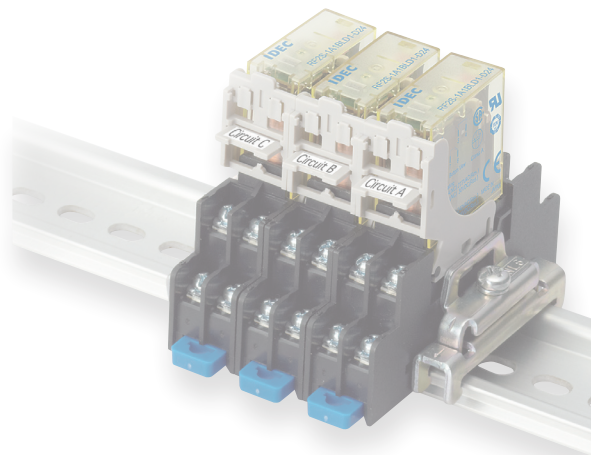
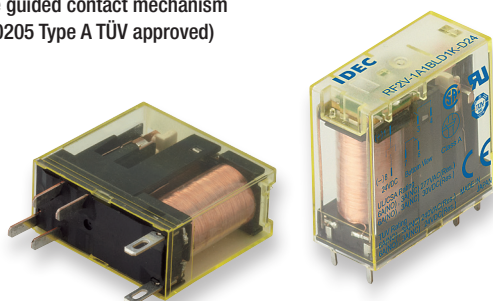

### RF2 2-pole Force Guided Relays

User-friendly functions

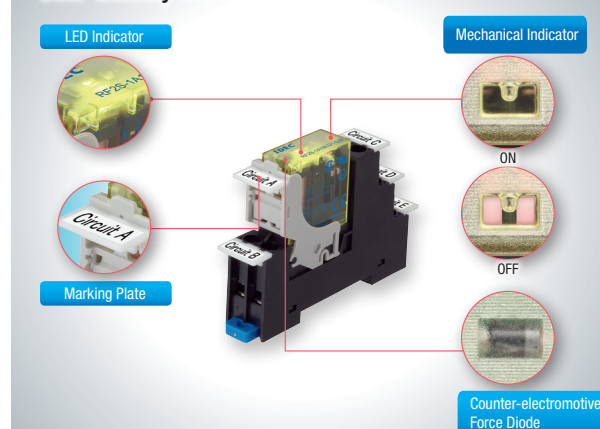

### SJ Series Relay Sockets

PC board and DIN-rail sockets available

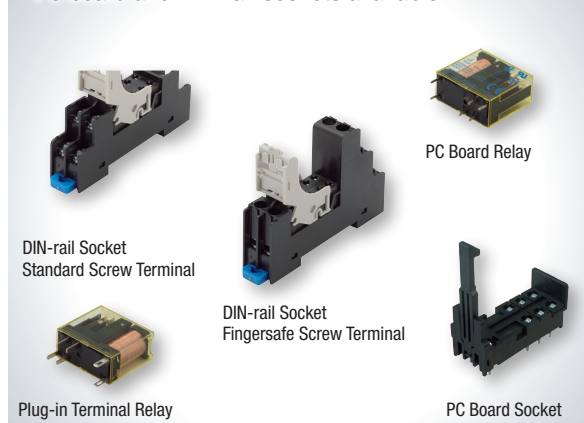

• Relay sockets can be used on plug-in terminal relays only, and cannot be used on PC board relay.

# IDEC CORPORATION

 [www.idec.com/usa](http://www.idec.com/usa)

#### Head Office

6-64, Nishi-Miyahara-2-Chome, Yodogawa-ku, Osaka 532-0004, Japan

<b>USA</b>	IDEC Corporation	Tel: +1-408-747-0550	opencontact@idec.com
<b>Germany</b>	IDEC Elektrotechnik GmbH	Tel: +49-40-25 30 54 - 0	service@eu.idec.com
<b>Singapore</b>	IDEC Izumi Asia Pte. Ltd.	Tel: +65-6746-1155	info@sg.idec.com
<b>Thailand</b>	IDEC Asia (Thailand) Co., Ltd	Tel: +66-2-392-9765	sales@th.idec.com
<b>Australia</b>	IDEC Australia Pty. Ltd.	Tel: +61-3-8523-5900	sales@au.idec.com
<b>Taiwan</b>	IDEC Taiwan Corporation	Tel: +886-2-2698-3929	service@tw.idec.com

<b>Hong Kong</b>	IDEC Izumi (H.K.) Co., Ltd.	Tel: +852-2803-8989	info@hk.idec.com
<b>China/Shanghai</b>	IDEC (Shanghai) Corporation	Tel: +86-21-6135-1515	idec@cn.idec.com
<b>China/Shenzhen</b>	IDEC (Shenzhen) Corporation	Tel: +86-755-8356-2977	idec@cn.idec.com
<b>China/Beijing</b>	IDEC (Beijing) Corporation	Tel: +86-10-6581-6131	idec@cn.idec.com
<b>Japan</b>	IDEC Corporation	Tel: +81-6-6398-2527	marketing@idec.co.jp

Specifications and other descriptions in this brochure are subject to change without notice.  
2017 IDEC Corporation, All Rights Reserved.

©2017 IDEC Corporation. All Rights Reserved. RF1V-DS100-0a 8/17 PDF ONLY

